

Taras Postranskyy, Kateryna Khoreva

Lviv Polytechnic National University
12, S. Bandery Str., Lviv, 79013, Ukraine

© T. Postranskyy, K. Khoreva, 2022
<https://doi.org/10.23939/tt2022.02.063>

THE INFLUENCE OF THE TRAFFIC LIGHT'S PERMISSIVE SIGNAL SHARE ON THE DURATION OF TRAFFIC DELAYS

Summary. *Today, the motorization level and the value of traffic flow on the street-road network have increased. Often this leads to an excessive load on the existing traffic management system, highways, and roads. As a result, the number and duration of traffic delays are increasing, especially within populated areas. The consequence of this is the formation of traffic jams, increase of fuel and lubricants consumption, noise pollution, and emissions of exhaust gases. Another, no less critical consequence is an increase in traffic accidents, particularly at unsignalized intersections. Therefore, a traffic light control system is often implemented at street intersections to increase traffic safety and reduce the number of conflicting flows. In addition, this system should be optimized for signalized objects.*

The object of the study is a signalized intersection of multi-lane streets located in the city. The main problem that needs to be solved is the reduction of the vehicles' delay duration at the approaches to such intersections, in particular with the use of appropriate organizational measures and planning of the traffic light control system. According to the study's results, regularities were revealed regarding the change in the traffic's delay duration depending on the share of the permissive signal and the duration of the traffic light's cycle at the street intersection. At the same time, the received modulation results in the PTV Vissim software environment indicate an increase in delay values with an increase in the duration of the traffic light cycle. However, an equally important influence factor is the share of the permissive signal, as it reduces to a certain extent the duration of vehicles in standby mode at the approaches to the signalized intersection. The obtained results are recommended to be used in both developing new traffic organization schemes at signalized street intersections and improving existing ones.

Key words: *traffic flow, traffic delay, traffic light control, duration of the traffic light cycle, signalized street intersection.*

1. INTRODUCTION

The increase in the number of vehicles and the level of motorization leads to the emergence of a considerable number of transport problems, in particular in populated areas. This leads to a decrease in the functioning of the “driver – car – road – environment” system. As a result, new tasks appear to improve existing and design new traffic management schemes. Often, it is necessary to reorganize the street-road network, as well as to introduce and improve the system of traffic light control to solve mentioned transport problems. This will make it possible to reduce the number of traffic jams on the streets and roads, the time lost by the people for movement, increase the level of safety, and improve the environmental situation, etc. [1, 2].

The rapid increase in the number of cars leads to an increase in the traffic flow volume. It leads to the need of implementing traffic lights at intersections, and to the introduction of changes to increase the efficiency of traffic light control at equipped ones. At the same time, a common phenomenon in domestic

practice is the creation of a constantly fixed duration for each signaling phase, which is calculated based on researched statistical data on traffic flow parameters. However, frequent changes in traffic intensities and the composition of traffic flows lead to a decrease in the effectiveness of this regulation method [2-4]. However, on the sections of the street network where traffic management at the intersection is organized only by road signs, significant delays in secondary traffic directions often occur. This value directly depends on the traffic volume in the main direction. Therefore, in proportion to the number of vehicles at the intersection of streets, there is a need to install traffic lights to regulate movement. At the same time, this approach should ensure minimal traffic flow delays at the intersection in general [5, 6].

2. RESEARCH STATEMENT

The aim of the study is to identify the regularity of the change in the traffic delay duration depending on the share of the permissive signal at the signalized street intersection. To achieve this, the following tasks are accomplished:

- researching primary traffic flow indicators at signalized street intersections;
- simulation of the operation street intersection in the PTV Vissim software environment under various parameters of traffic light control;
- determination of changes` patterns in the duration of the traffic delay at the approaches to the intersection depending on the permissive signal`s share;
- development of practical recommendations for taking into account the research results.

3. TRAFFIC LIGHT CONTROL AND TRAFFIC FLOW DELAYS

Today, traffic light control is one of the effective ways to increase traffic safety at intersection and the efficiency of its operation in general. One of the key elements of traffic light control is the duration of its cycle and phases. The output data of the local fixed-time control, as a rule, is equal to the period of maximum loading of the section or intersection and does not take into account the changes in traffic flows throughout the time. At the same time, with a fixed-time multi-program switching of the traffic light, it can be carried out according to the period of the day and days of the week, summer and winter periods, different weather conditions (rain, snow, ice), etc. [2, 7].

At intersections with high traffic volume, there is an increased danger for both – cars and pedestrians. As a result, traffic light control systems are most often introduced for this purpose, significantly increasing road safety. However, after implementing the traffic light at the intersection, traffic delays increase. Therefore, the use of traffic light control systems must be checked based on the feasibility of their use.

Traffic delay at a signalized intersection is a delay that occurs as a result of a reduction in the speed of motor vehicles due to traffic light signals. The delay value is the difference between the actual duration of the car passage through the intersection and the duration of the same passage in free traffic conditions without the influence of traffic light control [7, 8].

In simplified calculations, a dependence is most often used to determine the average delay (d) of one vehicle, which is based on the assumption that the average duration of the delay will be equal to half the time during which traffic movement is prohibited [9].

However, in general, the arrival of a vehicle at an intersection is a random process that is important to predict. Webster proposed a formula that takes into account random situations. The average length of one vehicle`s delay on the approach to a signalized intersection with a fixed-time control cycle can be calculated using the following formula [9]:

$$d = \frac{T_c(1-\lambda)^2}{2(1-\lambda x)} + \frac{x^2}{2N(1-x)} - 0.65 \left(\frac{T_c}{N^2} \right)^{\frac{1}{3}} x^{2+5\lambda}, \quad (1)$$

where T_c – the duration of the traffic light cycle; λ – the ratio of the green signal duration to the duration of the cycle; x – the degree of saturation of the direction of movement; N – the traffic volume in the studied direction, unit/s.

Thus, one of the main disadvantages is the increased delay of the vehicle when traffic lights are installed. Webster's formula for calculating transport delays (formula (2)) laid the foundation for an experiment to find the values of the signaling cycle that could minimize the total transport delay [10]. With the help of this method, the dependence of an individual vehicle's average delay on the duration of the traffic light cycle was determined, which is shown in Fig. 1 [7].

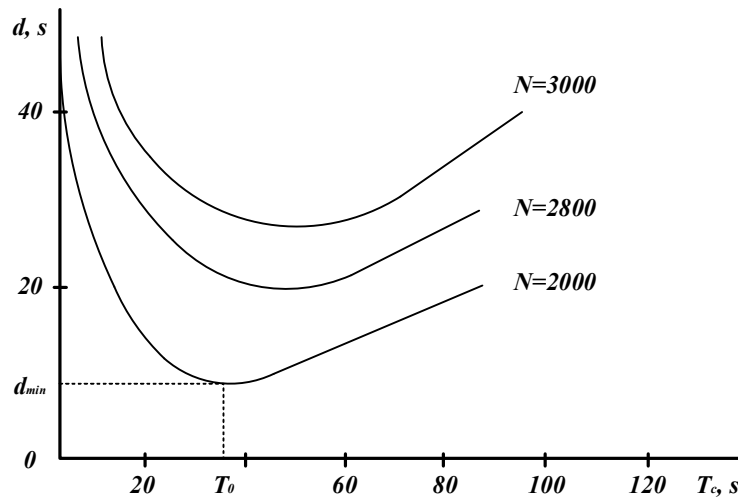

Fig. 1. Dependence of the vehicle's average delay on the duration of the traffic light cycle [7]

According to the data shown in Fig. 1, it can be stated that [7]:

- the smallest delay will be at point T_0 ;
- as the cycle time increases, the delay will increase;
- when the cycle duration decreases, it will also increase;
- within the range of $0.75 T_0$ to $1.5 T_0$, the transport delay is 10–15 % greater than the minimum d_{min} value.

The main disadvantage of this method is its inability to use with a dense traffic flow since then the degree of traffic saturation is $\chi \geq 1$, which leads to infinite delay values [7, 10].

In scientific research [11], with the help of simulation modeling in the PTV Vissim, the influence of the traffic light control system on the waiting time for the opportunity to pass through the intersection for the green light (W) was established:

$$W = \frac{t_p^2(1 + \mu\Delta)}{2T_c}, \quad (2)$$

where μ – traffic volume approaching the intersection in a specific direction; Δ – the time during which the car passes the intersection, s.

This method works under the condition that all vehicles must pass within the time allowed by the traffic light signal. In this case, vehicle delays associated with waiting for the next green signal are not considered. Therefore, such calculations should be considered auxiliary in estimating vehicle delays at a signalized intersection, which does not consider volume-capacity ratio during delays [10].

4. TRAFFIC MODELING AND ANALYSIS OF THE OBTAINED RESULTS

Today, there are a significant number of methods for traffic simulation. They usually allow for performing a wide variety of tasks. Therefore, the methods of solving these problems require a special approach and different mathematical calculations depending on the characteristics of the traffic. One of the modern solutions in transport modeling is the use of appropriate software. Products from the PTV Group,

in particular PTV Vissim and PTV Visum, were widely used in this case. This software allows for developing strategic planning, calculating transport demand, carrying out transport network analysis, as well as carrying out traffic simulation, checking the feasibility of engineering solutions for traffic management [9–13].

Microscopic transport models created in PTV Vissim reflect the current state of the street-road network at the level of the individual vehicles' and pedestrians' interaction, where initial data are collected based on a survey. Such type of simulated transport model allows for analysis [12, 14, 15]:

- capacity of the transport network depending on the type of intersection;
- the impact of changing traffic management on the parameters of traffic and pedestrian flows;
- improvement of the traffic signal system;
- the interaction of pedestrians with vehicles.

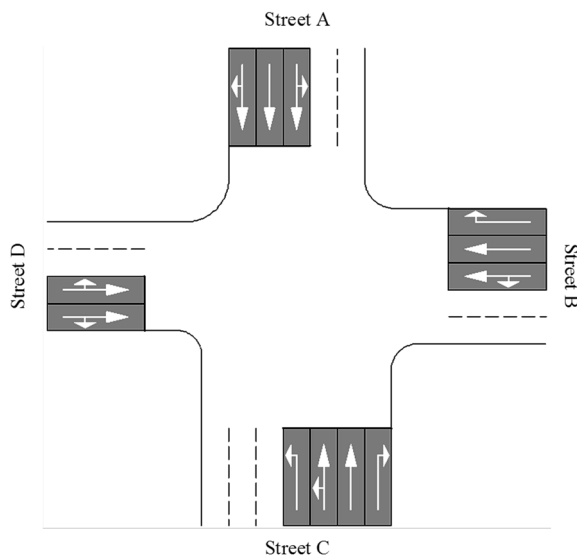

Fig. 2. The existing scheme of traffic flows at the studied intersection

An X-shaped intersection (Fig. 2) with significant traffic volume was chosen as the object of the study. This choice is due to the fact that in big cities, traffic problems often arise precisely at the intersection of arterial streets.

The main road at the intersection is an arterial street with signalized traffic (Street A – Street C). It consists of a multi-lane carriageway (lane width 3.75 m), the lanes of which are partially channelized. Other streets have a lane width of 3.5 m.

Analyzing traffic parameters at the studied intersection was conducted on working days of the week. Measurements of the traffic flows' composition (Fig. 3), the traffic volume (Fig. 4), as well as the cycle of traffic light control (Fig. 5 and Fig. 6), and other elements of traffic management were carried out at the intersection using different research methods.

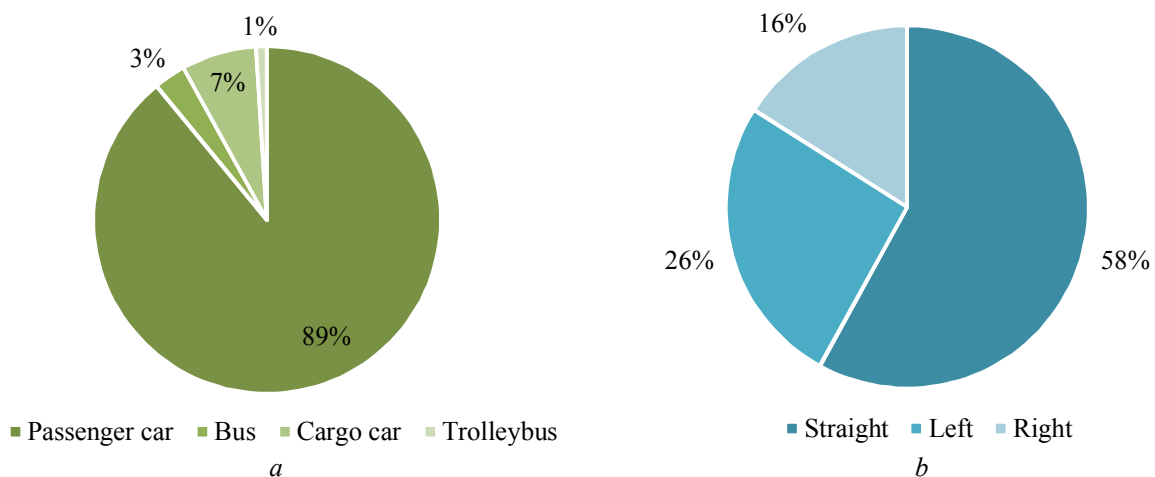

Fig. 3. Distribution of traffic flows at the investigated street intersection: a – by composition; b – by direction

As can be seen from Fig. 3, the traffic flow is dominated by passenger cars.

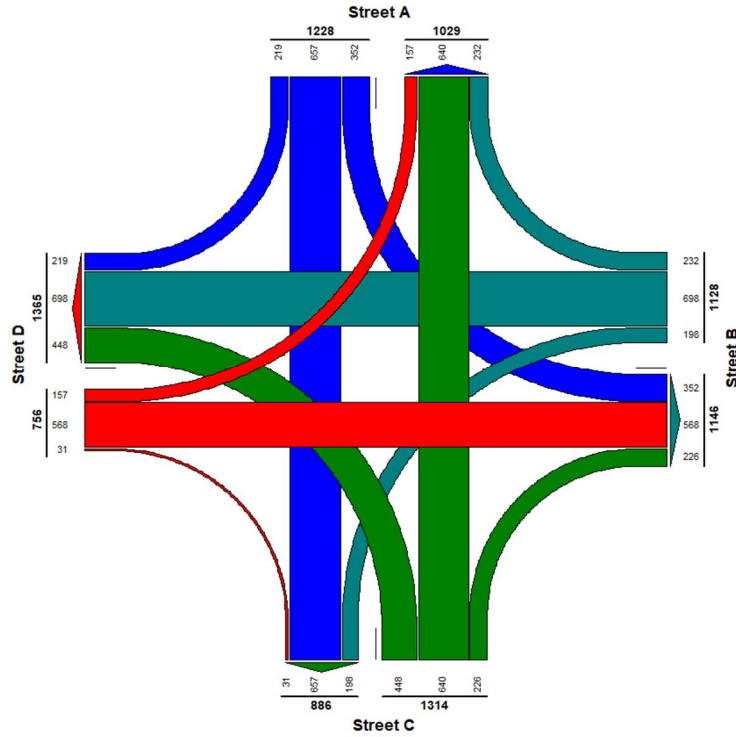

Fig. 4. Graph of the traffic volume at the investigated street intersection

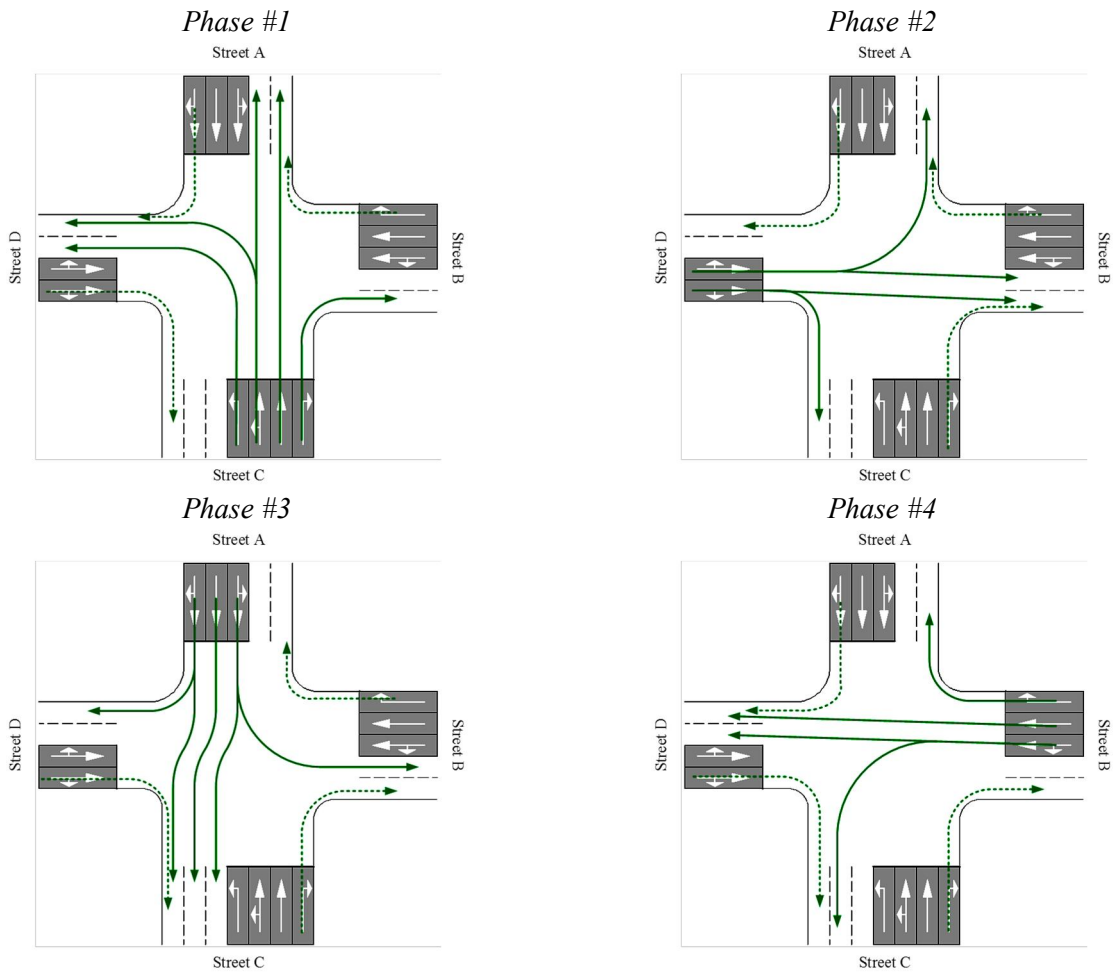

Fig. 5. Phase-to-phase movement of the vehicles at the investigated street intersection

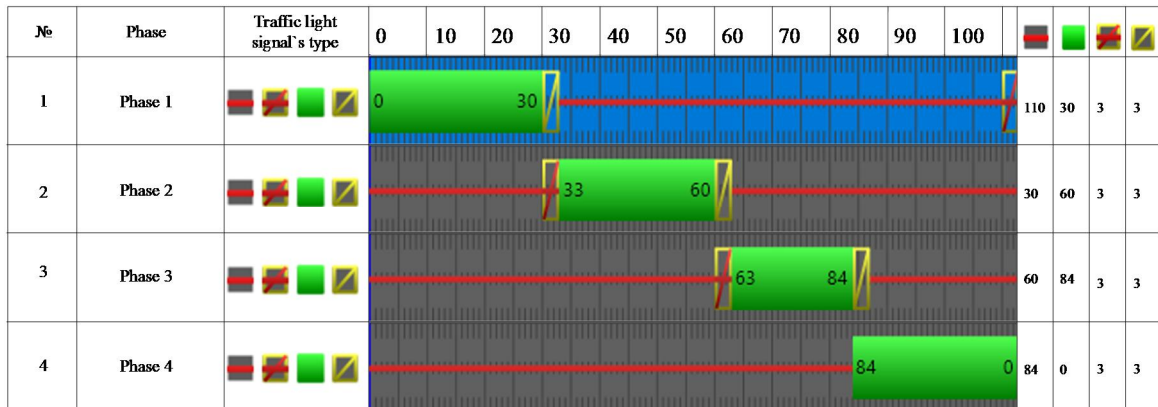

Fig. 6. The existing cyclogram of traffic light control

Generally, the existing traffic management scheme at the studied intersection can be considered adequate. Asphalt coverage at the intersection and its approaches are in good condition. Due to the high traffic volume, there are traffic jams before traffic lights (especially on streets A and C), which in a certain way indicates a large number of transit slow-moving vehicles (buses, trucks, etc.).

PTV Vissim software was used to simulate traffic flows and determine delays. After downloading the satellite map, road sections that form the investigated street intersections (Fig. 7a, b) were created. At each intersection, appropriate traffic priorities for secondary or primary directions are established (Fig. 7c), as well as traffic speed limits on connecting road sections.

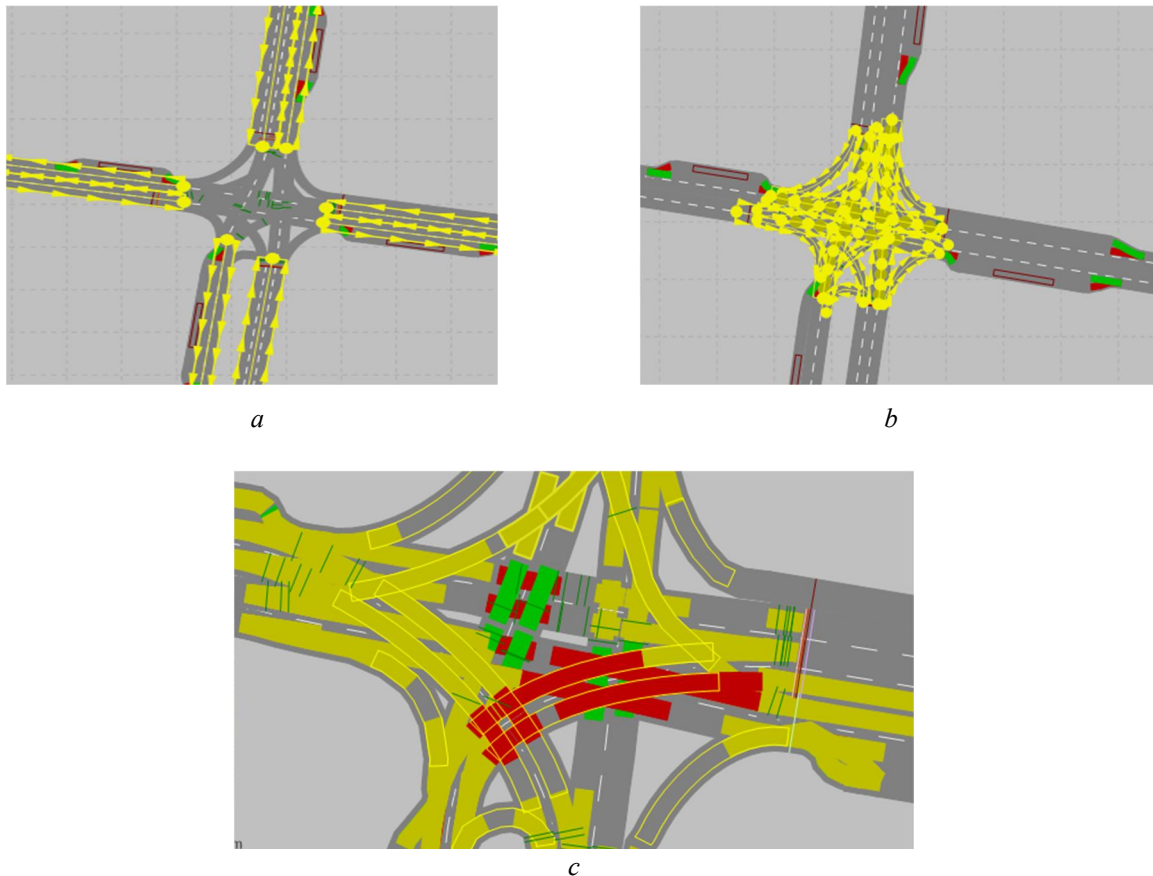

Fig. 7. Creation of an intersection model in the PTV VISSIM software:
 a – creation of approaches to the intersection; b – creation of sections of roads within the intersection; c – creation of departure priorities.

New cycle lengths are proposed to research traffic delays depending on the length of the traffic light cycle at signalized intersections, particularly: 100, 105, 110, 115, and 120 s. In existing traffic conditions at the intersection, the cycle duration is 113 seconds. When the cycle changes, the duration of its prohibitive and permissive signals also changes. In the process of the research, the proportion of the permissive signal's duration relative to the duration of the signaling cycle was calculated according to the methodology proposed by Webster [7, 9].

The conducted simulations of the intersection operation made it possible to obtain relevant data on vehicle traffic delays at intersections. According to this, graphic (Fig. 8) and mathematical (formula 4) dependences which reflect the influence of the share of the permissive signal on the duration of the transport delay were developed.

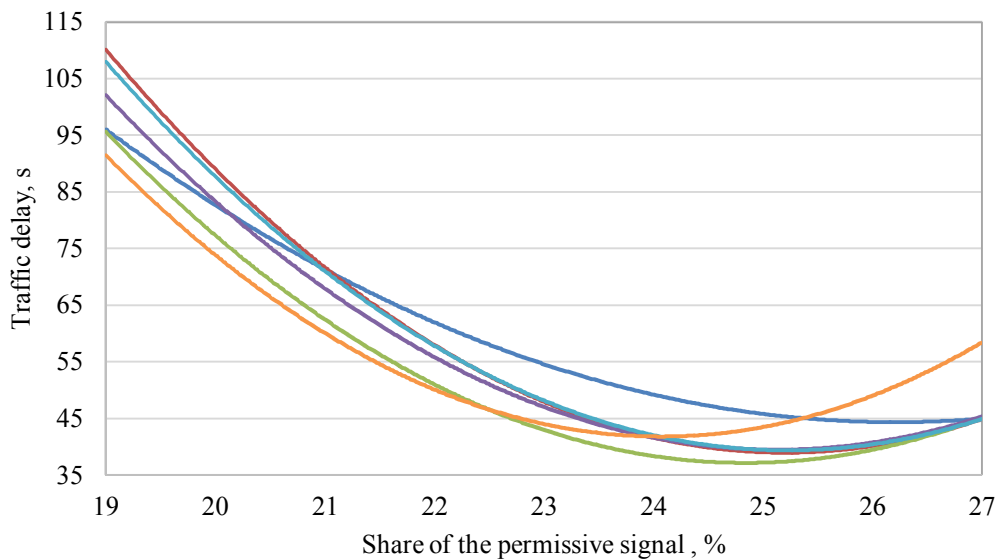

Fig. 8. Change in the duration of traffic delays depending on the share of the permissive signal at the intersection:

— cycle duration 100 — cycle duration 105 — cycle duration 110
 — cycle duration 113 — cycle duration 115 — cycle duration 120

$$d = 0.9943 \cdot \lambda_3^2 - 52.117 \cdot \lambda_3 + 727.32, \quad (3)$$

where λ_3 – share of the permissive signal, %.

Formula (4) is presented as a quadratic equation and mathematically reflects the dependence of transport delays on the duration of the permissive signal. The minimum delay is set at a percentage of the permissive signal of 25 % and a cycle duration of 110 s. In this case, it is 39 s. However, the maximum delay at studied intersection is at the cycle duration of 105 s and the share of the permissive signal 19 %. In this case, it is 136 s.

Thus, it can be argued that increasing the duration of the traffic light cycle is not always practical. The duration of the transport delay is largely affected by the share of the permissive signal from the total duration of the traffic light control cycle. An equally important influencing factor is the value of the phase saturation coefficient, which considers both the volume of the traffic flow and the saturation flow in each of the signaling phases.

5. CONCLUSIONS

1. Studies of traffic flow parameters were carried out. According to this, the composition of the traffic flow and the share of vehicles moving in different permitted directions were determined. This was the initial data for creating a model of the intersection in the PTV Vissim software environment. Based on this, the existing traffic delays at the signalized street intersection were determined.

2. The developed model in the PTV Vissim software envisages a change in traffic light control parameters without changing the traffic management scheme at the intersection. Based on this, vehicle movement was simulated, and the average value of the duration of the delay of vehicles in the flow was determined depending on the duration of the traffic light control cycle and its phases. Based on this, it was established that traffic delays depend on both the duration of the cycle and the share of the permissive signal.

3. Based on the modeling results, mathematical and graphical dependencies that reflect the dependence between the duration of traffic delays and the share of the permissive signal in the cycle of traffic light control were established. At the same time, it was found that the optimal share of the permissive signal ranges from 23–26 %.

4. The established values should be taken into account during the development of traffic management schemes at intersections and designing new and improving existing traffic light control systems. In particular, the application of the proposed mathematical model will reduce the duration of traffic delays and, as a result, reduce the probability of traffic jams, the level of environmental pollution, the level of noise, etc.

References

1. Makino, H., Tamada, K., Sakai, K., & Kamijo, S. (2018). Solutions for urban traffic issues by ITS technologies. *IATSS research*, 42(2), 49–60. doi: 10.1016/j.iatssr.2018.05.003 (in English).
2. Fornalchyk, Y., Kernytskyi, I., Hrytsun & O., Royko, Y. (2021). Choice of the rational regimes of traffic light control for traffic and pedestrian flows. *Scientific Review Engineering and Environmental Studies (SREES)*, 30 (1), 38–50. doi: 10.22630/pniks.2021.30.1.4 (in English).
3. Wang, Y., Yang, X., Liang, H., Liu, Y. (2018). A Review of the Self-Adaptive Traffic Signal Control System Based on Future Traffic Environment. *Journal of Advanced Transportation*, 2018, 1–12. doi: 10.1155/2018/1096123 (in English).
4. Chen, P., Liu, H., Qi, H., Wang, F. (2013). Analysis of delay variability at isolated signalized intersections. *Journal of Zhejiang University SCIENCE A*, 14 (10), 691–704. doi: 10.1631/jzus.a1300208 (in English).
5. Polishhuk V. P., Bakulich O. O., Dzyuba O. P. et al. (2014). *Organizaciya ta reguluvannya dorozhn'ogo ruxu: pidruchnyk [Organization and regulation of road traffic]*. Kyiv: Znannya Ukrainy. (in Ukrainian).
6. Alex, Sheela & Isaac, Kuncheria (2014). Traffic Simulation Model and Its Application for Estimating Saturation Flow at Signalised Intersection. *International Journal for Traffic and Transport Engineering*, 4. 320–338. doi: 10.7708/ijtte.2014.4(3).06 (in English).
7. Polishhuk V. P., Bakulich O. O., Dzyuba O. P. et al. (2014). *Organizaciya ta reguluvannya dorozhn'ogo ruxu: pidruchnyk [Organization and regulation of road traffic]*. Kyiv: Znannya Ukrainy (in Ukrainian).
8. Modely opredeleniya koeffitsyentov pryvedeniya k lehkovomu avtomobilyu dlia rehulyuemykh peresecheniy [Models for determining the coefficients of reduction to passenger car for regulated crossings]. Retrieved from: <https://docs.python.org/3lastaccessed2022/10/03> (in Russian).
9. Fornalchyk, Ye. Yu., Mohyla, I. A., Trushevskiy, V. E. & Hilevych, V. V. (2018). *Upravlinnia dorozhnim rukhom na rehulovanykh perekhrestiakh u mistakh [Traffic management at regulated intersections in cities]*. Lviv: Lviv Polytechnic Publishing House (in Ukrainian).
10. Zakariya, A. Y., & Rabia, S. I. (2016). Estimating the minimum delay optimal cycle length based on a time-dependent delay formula. *Alexandria Engineering Journal*, 55(3), 2509–2514. doi: 10.1016/j.aej.2016.07.029 (in English).
11. Trushevsky V.E. (2015). *Udoskonalennia svitlofornoho rehuluvannya pry orhanizatsii rukhu za okremymy napriamkamy [Improvement of traffic light regulation with separate directions traffic management]*. Candidate's thesis. Kyiv: NTU (in Ukrainian).
12. PTV Vissim 10 User manual (2018). Retrieved from: <https://usermanual.wiki/Document/Vissim20102020Manual.1098038624.pdf> (in English).
13. Jin, S., Wang, J., & Jiao, J. (2013). The Study in Diamond Interchange Traffic Organization. *Procedia – Social And Behavioral Sciences*, 96, 591–598. doi: 10.1016/j.sbspro.2013.08.069 (in English).
14. Weyland, C. M., Baumann, M. V., Buck, H. S., & Vortisch, P. (2021). Parameters influencing lane flow distribution on multilane freeways in PTV VISSIM. *Procedia Computer Science*, 184, 453–460. doi: 10.1016/j.procs.2021.03.057 (in English).

15. Istiqomah, N., & Qidun, M. B. (2018). Traffic simulation in an intersection by using integrated Vissim-MATLAB. In *2018 International Conference on Sustainable Energy Engineering and Application (ICSEEA)*, pp. 122–127. doi: 10.1109/ICSEEA.2018.8627116 (in English).

Received 14.09.2022; Accepted in revised form 05.10.2022.

ВПЛИВ ЧАСТКИ ДОЗВІЛЬНОГО СИГНАЛУ СВІТЛОФОРНОГО РЕГУЛЮВАННЯ НА ТРИВАЛОСТІ ТРАНСПОРТНИХ ЗАТРИМОК

***Анотація.** На сьогодні спостерігається збільшення як рівня автомобілізації, так й інтенсивностей руху транспортних потоків на вулично-дорожній мережі. Часто це призводить до надмірного навантаження на існуючу систему організації дорожнього руху та шляхи сполучення. Як наслідок, зростає кількість та тривалість транспортних затримок у русі, особливо у межах населених пунктів. Наслідком цього є утворення транспортних заторів, збільшення рівня витрати паливо-мастильних матеріалів, рівня шумового забруднення та викидів відпрацьованих газів. Іншим, не менш важливим наслідком є підвищення рівня аварійності руху, зокрема на нерегульованих перехрестях. Відповідно, для підвищення безпеки руху та зниження кількості конфліктуючих потоків, часто на таких перехрестях впроваджують систему світлофорного регулювання, а на регульованих об'єктах здійснюється її оптимізація.*

Об'єктом дослідження є регульоване перехрестя багатосмугових вулиць, яке розташоване у межах населеного пункту. В якості головної проблеми, що потребує вирішення, обрано зменшення тривалості затримки транспортних засобів на підходах до таких перехресть, зокрема із застосуванням відповідних організаційних заходів та планування роботи системи світлофорного регулювання. За результатами дослідження виявлено закономірності щодо зміни тривалості транспортних затримок залежно від частки дозвільного сигналу та тривалості циклу регулювання на перехресті вулиць. При цьому, отримані результати моделювання у програмному середовищі PTV Vissim свідчать про те, що існує зростання значень затримок із збільшенням тривалості циклу світлофорного регулювання. Проте, не менш важливим чинником впливу є і частка дозвільного сигналу, оскільки вона дозволяє до певної міри знижувати тривалість перебування транспортних засобів у режимі очікування на підходах до регульованого перехрестя. Отримані результати рекомендовано використовувати як при розробленні нових схем організації дорожнього руху на регульованих перехрестях, так і при вдосконаленні вже існуючих.

***Ключові слова:** транспортний потік, транспортна затримка, світлофорне регулювання, тривалість циклу регулювання, регульоване перехрестя вулиць.*